

# User Manual

## 3Scope

Head-Mounted-Display (HMD) / Goggles

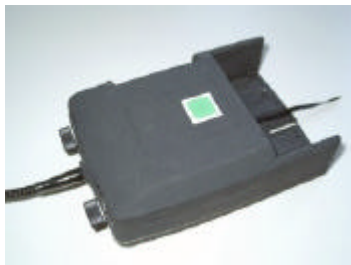

Subject to technical modifications

## **WARNING**

**Before using the 3Scope please read carefully these safety instructions.**

**Read this handbook and use the 3Scope device in strict accordance in order to prevent any damage to your eye, other injury, loss of visual functions, property damage or death.**

**Children under the age of fifteen may not use this product.**

**We strongly advise you to get familiar with the 3Scope device and its capabilities before you use it for the first time.**

---

## Table of Contents

---

<b>Table of Contents</b> .....	<b>3</b>
<b>1 Safety instructions</b> .....	<b>4</b>
1.1 Health concerns .....	4
1.2 General safety hints .....	5
1.3 Warning for electrical products .....	5
<b>2 Content of the 3Scope Kit</b> .....	<b>6</b>
<b>3 Description</b> .....	<b>7</b>
3.1 Head Mounted Display HMD / Goggles .....	7
3.2 Power unit .....	8
3.3 Charge unit .....	10
<b>4 General Operating Instructions</b> .....	<b>12</b>
4.1 Preparation .....	12
4.2 Connecting external video sources .....	15
4.3 Adjusting the Interpupil Distance .....	16
4.4 Exhausted Battery .....	16
4.5 Using 3Scope as a Monitor .....	17
4.6 Using different Modes.....	18
<b>5 Maintenance and Cleaning Instructions</b> .....	<b>20</b>
<b>6 Trouble Shooting</b> .....	<b>21</b>
<b>7 Technical Data</b> .....	<b>22</b>
7.1 Head Mounted Display / Goggles .....	22
7.2 Power unit .....	23

---

## 1 Safety instructions

---

---

### 1.1 Health concerns

---

➔ **WARNING:** Eye Disease, Eye Injury, and Glaucoma

If you have been diagnosed with or are susceptible to eye disease, eye injury, or glaucoma consult your doctor before use and do not use without your doctor's approval.

➔ **CAUTION:** Heart Disease, High Blood Pressure

If you have a history of heart disease or high blood pressure consult your doctor before use and do not use without his approval.

➔ **CAUTION:** Seizures

If you have a history of temporary spasm, unconsciousness, or epileptic seizures from light stimulation, consult your doctor before use and do not use without his approval.

If any of the following symptoms occur, if using 3Scope, stop using immediately and rest:

- eye fatigue or irritation,
- headaches or dizziness,
- aches and pain in the neck or shoulders,
- double vision,
- nausea or motion sickness,
- inability to focus on the displays.

Misuse or overuse of this product may result in eye damage, or loss of visual functions.

---

## 1.2 General safety hints

---

- ➔ Avoid getting the cable entangled around your neck, body or arms. Use the belt pouch for the power unit and wear the cable close to your body.
- ➔ To ensure that the device does not fall off during use, always use the elastic strap, and have it tightened with an adequate tension.

---

## 1.3 Warning for electrical products

---

- ➔ To avoid any risk of electrocution, do not bring any part of the 3Scope in contact with water when the power unit is connected to an AC outlet (e.g. when recharging batteries, using an external TV-, DVD-, Video- or PC-source).
- ➔ Avoid using and storing the 3Scope at wet, humid, dusty and smoky surroundings and extreme temperatures.
- ➔ Do not use 3Scope at temperatures below  $-10^{\circ}\text{C}$  and above  $+40^{\circ}\text{C}$ . Avoid dropping or mechanical shock, as frame and displays may be deformed.
- ➔ Always switch off and unplug the 3Scope when it will not be used.
- ➔ In case of damage contact your retailer. There are no user serviceable parts. Only qualified service personnel should perform any service required on this product.

---

## 2 Content of the 3Scope Kit

---

The 3Scope kit contains the following elements. Please check that all of these are included. If any item is not supplied contact your 3Scope dealer.

HMD or goggles (1),

Power unit (2), Battery (3),

AC/DC transformer with power cord (4), Charge unit (5),

Case (6), Cleaning cloth (7),

Video-Adapter-Cable (8)

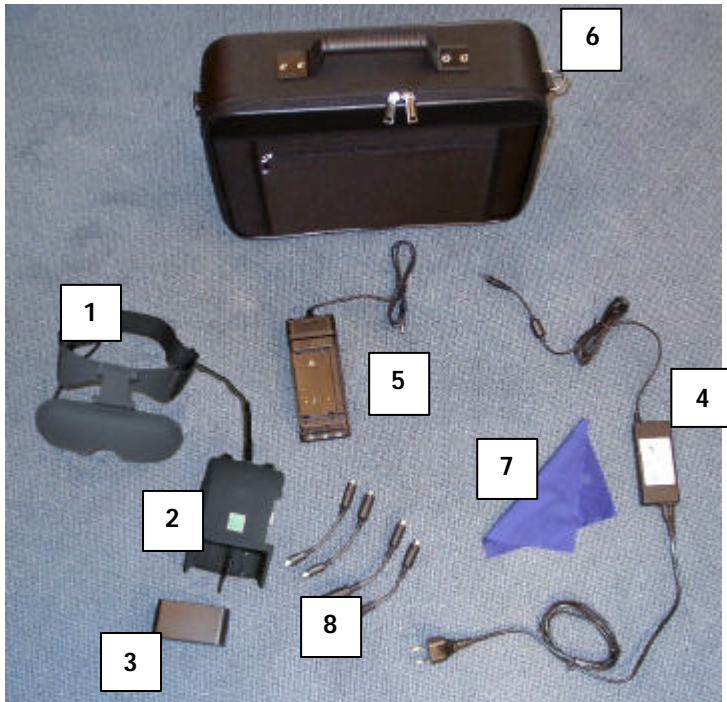

---

### 3 Description

---

---

#### 3.1 Head Mounted Display HMD / Goggles

---

The HMD contains two **microdisplays** (1) to show the images. The  **cable** (2) is permanently attached to the HMD and to the pocket element (power unit).

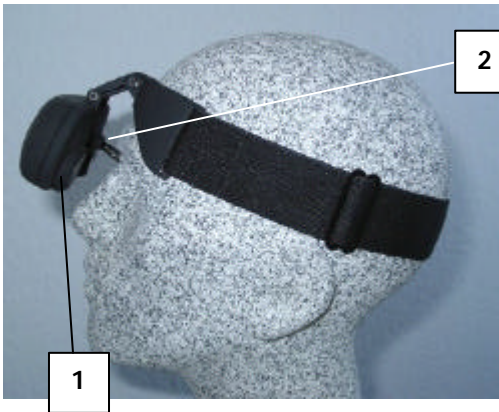

---

## 3.2 Power unit

---

The plastic casing contains the following elements:

- (1) Cable to HMD/goggles
- (2) Push button for power (illuminated)
- (3) Battery compartment
- (4) Connector for power supply (under the battery)
- (5) Knob for manual adjustment of brightness
- (6) Knob with double function: for manual adjustment of contrast, phase (depending upon the mode: see further).
- (7) Video in/out (details see further)

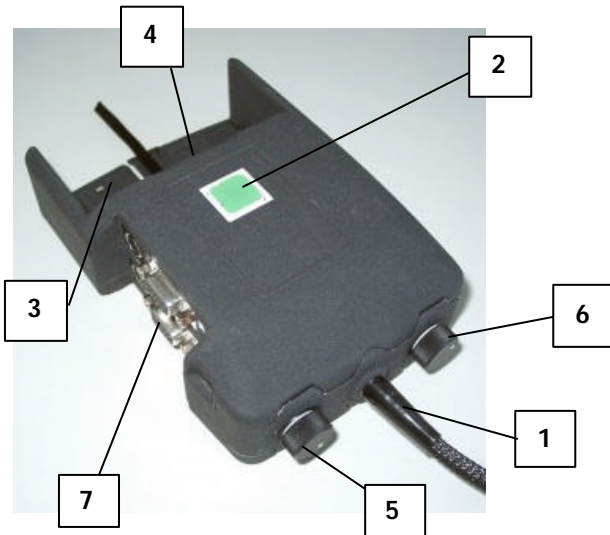

When the device is switched on, a light underneath the button lights up.

The removable Ni-MH **rechargeable battery** enables you to use the 3Scope for up to 4 hours (depending on used mode). When removing the battery, an **input connector (4)** for an external power supply becomes visible (see further).

The **knob on the left** (5, page 8) of the cable enables manual adjustment of brightness. The **knob on the right** (6, page 8) of the cable has a double function, it enables manual adjustment of contrast, of the zoom function or phase adjustment in VGA-mode.

The **power unit** also contains:

- (1) Button for selecting the input signal mode
- (2) Socket connector for external video signal L/R
- (3) Socket connector for external VGA sources L/R
- (4) Control lamps

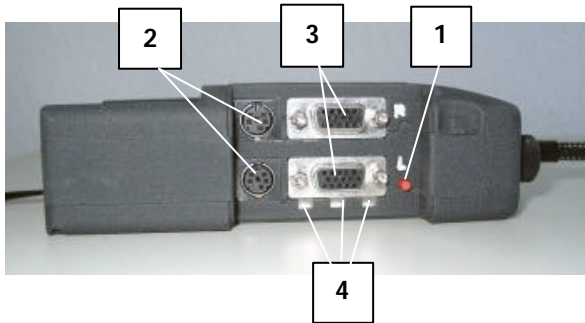

On the side of the device, there are **socket connectors for video/S-video L/R** (2) or **SVGA L/R** (3).

An input **selection button** (1) for selecting the mode corresponding to the input signal. Underneath are **three control lamps indicating the active choice** (6).

---

### 3.3 Charge unit

---

3Scope includes a removable Ni-MH rechargeable battery (2) and a power supply unit (1) for generating different voltages, which also includes a charging circuit for a mains adapter (3). It takes approx. 50 min to charge the battery from empty to full if you use the mains adapter supplied with the system. During charging process it is possible to use 3Scope parallel.

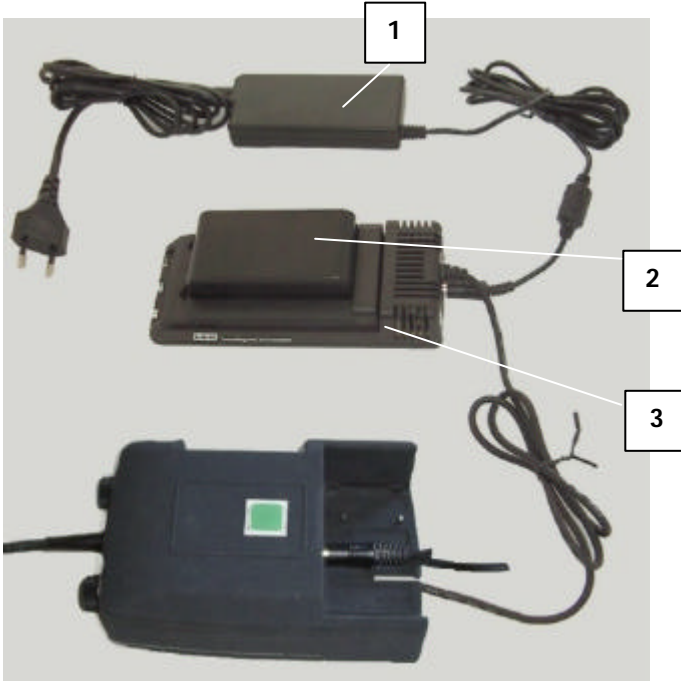

The charge unit has control lights.

- ➔ When loading the unit with a battery to be charged, the **red light** will turn **on**, but only for a while. It should turn off after a certain time (not more than a minute), otherwise it indicates a defect.
- ➔ If voltage input is incorrect or unstable, the **red light** lights up.
- ➔ When charging starts the **green light** will be **on**.
- ➔ When charging is completed, the **green light** will begin to **flash**.
- ➔ The **yellow light** is in relation with the temperature control. If it turns on, the maximum temperature allowed has been reached, and loading is temporarily interrupted.

You may leave the battery in the charge unit without any danger, until charging is complete (= green light flashing).

---

## 4 General Operating Instructions

---

---

### 4.1 Preparation

---

#### Unpacking the Device

- ➔ Please unpack the devices and compare with the list under paragraph 2 on page 6 to check that all parts are complete. Please contact your dealer if any parts are missing.

#### Checking, charging and changing the Battery

Before you use the HMD for the first time, please check whether the battery is fully charged:

- ➔ Remove the battery from the power unit. To do so, pull the tape down carefully with one hand and push the battery out of the casing with the thumb of your other hand. For that process do not lay down the power unit on the table.

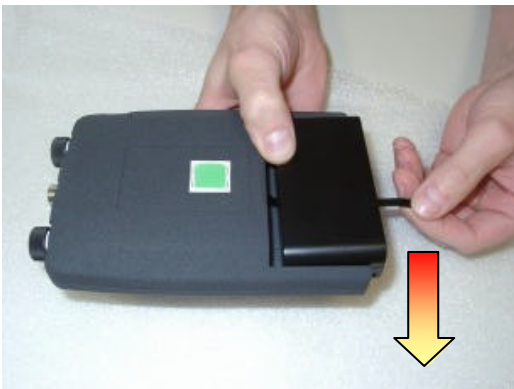

- ➔ Place the battery in the charger so that the brass-coloured contacts of the battery and charger match. Press the battery lightly until you feel it locks into place. The green control lamp on the front of the charger lights up. When the green control lamp begins to flash, the charging process is completed (see paragraph 3.3 on page 10).
- ➔ Replace the battery in the power unit. To begin with, this may require some practice. Please make sure that the contacts of the battery and the power unit match. Holding the battery flat, push it into the power unit as far as the mark. Press down the battery lightly with your thumb and at the same time continue pushing it completely into the power unit until it locks into place. For that process do not lay down the power unit on the table.

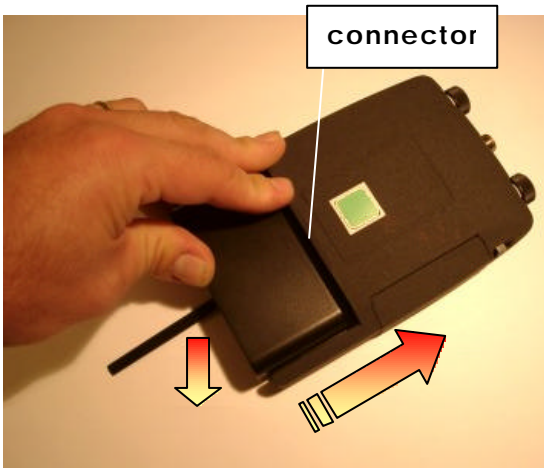

## Using the HMD with external power supply

It is possible to have the power supply coming from an external source. One such source is the AC/DC transformer that comes with the charge unit. Its output is 12 V DC, available at the special plug. This plug (see also(4) page 8) fits in in the connector at the battery location of the power unit (visible when the battery is removed).



---

## 4.2 Connecting external video sources

---

Choose two of the video adapter cables supplied with the system and plug into the socket connectors underneath the flap. Turn on the video source and select the appropriate mode by pushing the select button (1). For further details about different modes see 4.6 page 18.

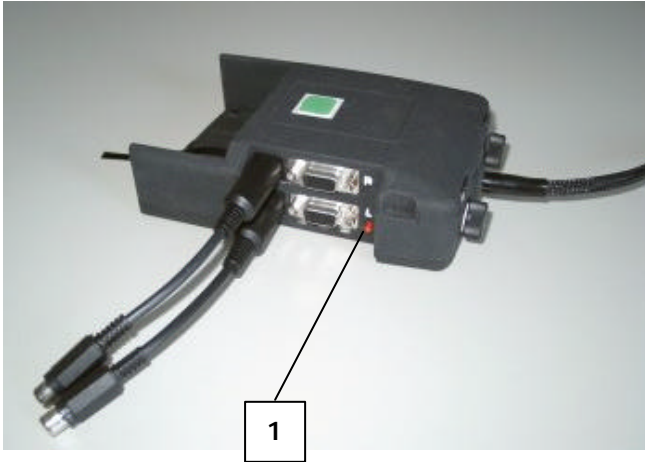

---

### 4.3 Adjusting the Interpupil Distance

---

To optimize the position of the two displays, so that both images are seen as a single visual field, carefully move the oculars into the right position.

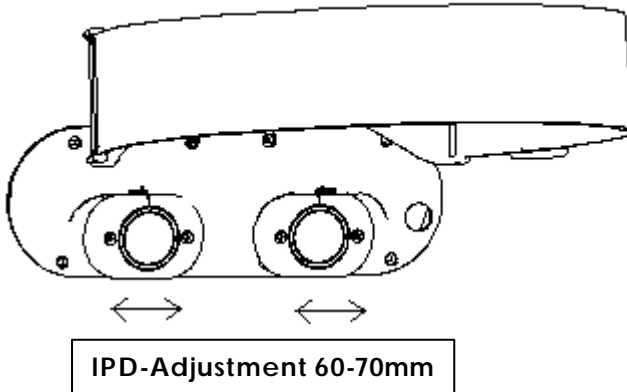

---

### 4.4 Exhausted Battery

---

When the the battery power is exhausted the illuminated power button will start blinking and a red frame appears around the image. Within a few minutes the system will stop working.

---

## 4.5 Using 3Scope as a Monitor

---

### Putting on the HMD

- ➔ Put on the 3Scope HMD. Place the headband around the back of your head and pull it just tight enough to make it fit safely and comfortably.
- ➔ On the displays inside the HMD, you can now see the pictures of your video source.
- ➔ Wearing the HMD you will see your surroundings only constricted. For this reason, please, move only carefully or not at all.

### Adjusting Brightness and Contrast

- ➔ Adjust **brightness** (1) and **contrast** (2) with the knobs beside the cable. Turn the knobs until the image quality you find best.

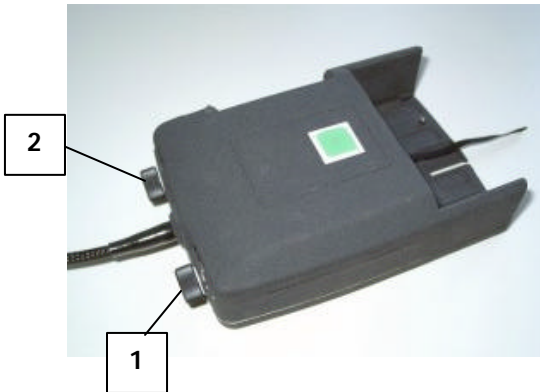

---

## 4.6 Using different Modes

---

The electronics of your 3Scope device allows different functions.

The selection of those functions is governed by the **push-button switch (PBS)** (1) that is located underneath the cover flap on the right hand side of the power unit.

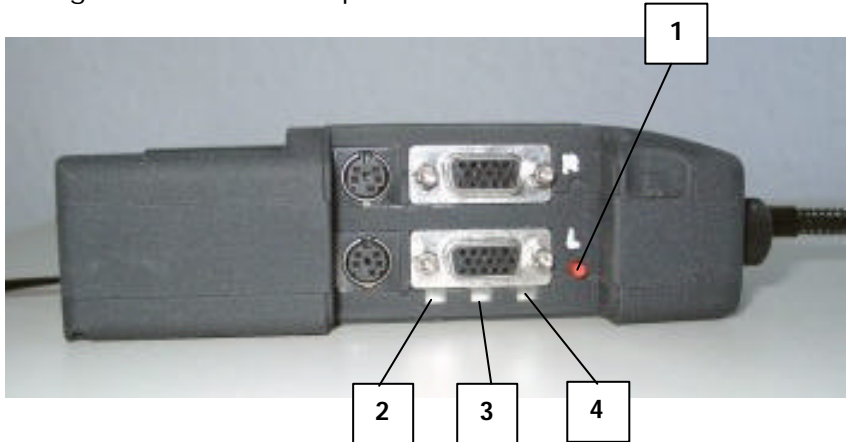

- ➔ The **basic mode** is the one where the 3Scope displays the images as captured by the VGA-adapter. You can apply a PC VGA signal 800x600@ 60Hz, 75Hz, 85Hz or 100Hz. With the contrast button (see "Power unit" page 8) you can adjust the phase of VGA-signal. The **right hand side green LED** (page 18, (4)) will be lit on. When no VGA signal is connected, this LED will be blinking.

- When pushing the push-button switch **PBS** (page 18, (1)) **once**, the device discerns between “composite video” or “S-video”, and it will equally recognise automatically whether it concerns a NTSC or PAL signal. The **middle green LED** (page 18, (3)) will be lit on to remind you of this mode. When no video signal is connected, this LED will be blinking. In this mode the two knobs beside the cable connection control the brightness and the contrast.
- Pushing the **PBS** (page 18, (1)) a **second time**, the electronic zoom is activated to magnify the external "composite video" or "S-video" signal. It can be noticed by the green frame that appears around both displays in the HMD and the **left and middle green LED** ((2)+(3) page 18) of power unit will be on. The adjustment of the electronic zoom is set by using the contrast knob on the right hand side of the cable connection.
- If the PBS is pushed a **third time**, the device goes back into basic mode.

Pushing PBS (1) page 18	3 green LEDs (2-4) page 18	Description
0x	[ ] [ ] [x]	standard mode = external VGA signal (after turning on device)
	[ ] [ ] [b]	no external VGA signal detected
1x	[ ] [x] [ ]	external video/S-video signal
	[ ] [b] [ ]	no external video signal detected
2x	[x] [x] [ ]	external video signal zoomed, green frame around image
	[b] [b] [ ]	no external video signal detected
3x	[ ] [ ] [x]	back to standard mode

[ ] = LED off

[x] = LED lit

[b] = LED blinking

---

## 5 Maintenance and Cleaning Instructions

---

To clean the HMD or goggles and control unit, use a damp cloth. A light rinsing agent may be added to the water. Do not use any detergents.

To clean the oculars of the HMD/goggles use a dry, clean cloth. A cleaning cloth for this purpose is provided with the 3Scope-kit.

In case of damage contact your retailer. There are no user serviceable parts. Only qualified service personnel should perform any service required on this product.

---

## 6 Trouble Shooting

---

<b>Problem</b>	<b>Cause</b>	<b>Remedy</b>
<b>Only dark, or only white image</b>	Incorrect brightness. Brightness knob and/or contrast knob are on max. or min. position.	Adjust by using brightness knob and/or contrast knob
<b>Completely white image</b>	After having used electronic zoom, contrast knob is "deregulated", i.e. at an extreme	readjust contrast
<b>No image</b>	Appliance switched off	switch on 3Scope with main push button
<b>No image</b>	Video cable connected, but wrong video source selected	either connect a video source and select compatible mode for this video signal with PBS

**All other problems should be performed by a trained and authorised service provider !**

---

## 7 Technical Data

---

---

### 7.1 Head Mounted Display / Goggles

---

Display .....	2x SVGA microdisplays 480,000 pixels colour equals 1,440,000 pixels
Field of view .....	approx. 40° diagonal
Eye distance .....	60-70 mm adjustable
Operating temperature.....	-10°C to +40°C
Weight HMD .....	120g
Dimensions (W/H/D).....	155mm/50mm/50mm

---

## 7.2 Power unit

---

Brightness.....	manually adjustable
Kontrast .....	manually adjustable
Digital magnifier.....	built-in electronic zoom 8x
Mode switch.....	3 modes
Basic mode.....	SVGA (from PC) 800 x 600@ 60/75/80/100Hz
Second mode.....	Composite video, S-video in NTSC or PAL
Third mode .....	external video zoomed
Weight .....	approx. 380 g (incl. battery)
Dimensions (W/H/D).....	105mm/155mm/25mm
Operating temperature.....	-10°C to +40°C
Battery .....	changeable + rechargeable Ni-MH 6V/2, 1Ah
Charging time.....	approx. 50 min, with enclosed power supply
Operating time.....	approximately based on standard batteries: 2 h (external video source) 4 h (external SVGA source)